



**EUROfusion**

WPBB-CPR(17) 17305

A. Bertinetti et al.

**Development of a thermal-hydraulic  
model of a Back Supporting Structure  
Segment of the EU DEMO HCPB  
Breeding Blanket**

Preprint of Paper to be submitted for publication in Proceeding of  
13th International Symposium on Fusion Nuclear Technology  
(ISFNT)



This work has been carried out within the framework of the EUROfusion Consortium and has received funding from the Euratom research and training programme 2014-2018 under grant agreement No 633053. The views and opinions expressed herein do not necessarily reflect those of the European Commission.

This document is intended for publication in the open literature. It is made available on the clear understanding that it may not be further circulated and extracts or references may not be published prior to publication of the original when applicable, or without the consent of the Publications Officer, EUROfusion Programme Management Unit, Culham Science Centre, Abingdon, Oxon, OX14 3DB, UK or e-mail [Publications.Officer@euro-fusion.org](mailto:Publications.Officer@euro-fusion.org)

Enquiries about Copyright and reproduction should be addressed to the Publications Officer, EUROfusion Programme Management Unit, Culham Science Centre, Abingdon, Oxon, OX14 3DB, UK or e-mail [Publications.Officer@euro-fusion.org](mailto:Publications.Officer@euro-fusion.org)

The contents of this preprint and all other EUROfusion Preprints, Reports and Conference Papers are available to view online free at <http://www.euro-fusionscipub.org>. This site has full search facilities and e-mail alert options. In the JET specific papers the diagrams contained within the PDFs on this site are hyperlinked

# Thermal-hydraulic Modeling of a Segment of the EU DEMO HCPB Breeding Blanket Back Supporting Structure

Andrea Bertinetti<sup>a\*</sup>, Antonio Froio<sup>a</sup>, Bradut-Eugen Ghidersa<sup>b</sup>, Francisco Alberto Hernández González<sup>b</sup>, Laura Savoldi<sup>a</sup>, Roberto Zanino<sup>a</sup>

<sup>a</sup>*NEMO group, Dipartimento Energia, Politecnico di Torino, C.so Duca degli Abruzzi 24, 10129 Torino, Italy*

<sup>b</sup>*Karlsruhe Institute of Technology, 76344 Eggenstein-Leopoldshafen, Germany*

The Helium-Cooled Pebble Bed (HCPB) concept for the Breeding Blanket (BB) of the EU DEMO tokamak reactor is under development at KIT within the EUROfusion consortium. Although the coolant distribution inside the blanket manifolds has been investigated in the past using 3D CFD models, such detailed analysis could not be extended to investigate the behavior of all blanket segments as a whole. Thus, for system-level analyses, lumped-parameter models are used, which exploit 0D/1D simplifications of the physics. This work presents the development of a 1D thermal-hydraulic (TH) model for the HCPB Back Supporting Structure (BSS). To validate such model, an experimental campaign is foreseen in 2018 in the HELOKA facility at KIT, in which a scaled-down mock-up of a segment of the BSS, which is dimensioned according to the facility working conditions, will be tested. Using the results of CFD simulations on full-size and mock-up, a first successful comparison between 3D and 1D results is presented. The 1D model is developed in such a way to allow a smooth integration in the GETTHEM code, which is under development at PoliTo, for the TH simulation of the entire tokamak.

Keywords: DEMO, breeding blanket, HCPB, Back Supporting Structure, thermal-hydraulics, modeling

## 1. Introduction

The Helium-Cooled Pebble Bed (HCPB) concept for the Breeding Blanket (BB) of the European DEMO tokamak reactor is under development at the Karlsruhe Institute of Technology (KIT) [1]. A sketch of the current layout of the HCPB Blanket Modules (BMs) in one DEMO sector, including the inlet and outlet coolant piping, is shown in Fig. 1a. All the BMs in the same segment are connected in parallel to the same Back Supporting Structure (BSS), containing the inlet/outlet manifolds (see Fig. 1b). In view of the poloidal length of the manifolds and of the different cooling needs of the BMs, the coolant mass flow rate distribution among the BMs has to be investigated; this is usually done in detail using 3D CFD software models [2]. Such analysis would nevertheless have a prohibiting computational cost when looking at the behavior of all blanket segments. Consequently, system-level tools with lumped-parameters should be developed, exploiting 0D/1D modelling. However, both (3D and 0D/1D) kinds of models still need to be validated against experiments, in order to assess their performance.

This work presents the development of a 1D model, which allows computing the pressure distribution within the manifolds, as well as a detailed mass flow rate distribution to the cooling channels. This model is fully compatible with, and ready for the integration in the GETTHEM code [3]. GETTHEM is a system-level, object-oriented, fast-running model for the dynamic analysis of the Primary Heat Transfer System of the EU DEMO tokamak, under development at Politecnico di Torino using the equation-based Modelica language, which was already successfully applied in the past to the optimization of the HCPB and Water-Cooled Lithium-Lead coolant distribution [3] [4].

An experimental campaign is foreseen in 2018 in the HELOKA facility at KIT [5], in which a scaled-down mock-up of a segment of the HCPB will be tested, aiming also at providing experimental data for the validation of the new BSS model presented in this paper.

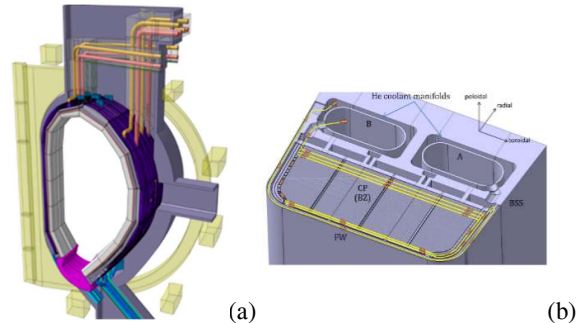

Fig. 1. Sketch of: (a) one sector of the EU DEMO reactor (2015 design) (reproduced from [2]); (b) the cross section of a HCPB BM, showing the BSS manifolds.

This work presents the dimensioning of such mock-up and the 1D BSS model. The inlet and the outlet manifolds of the BSS are scaled down maintaining hydraulic similarity conditions with respect to the full-scale BSS and the representativeness of the mock-up is successfully cross-checked on a single BM performing 3D CFD simulation with both full-size and sub-size geometries. The 1D model of the BSS is then introduced and its hydraulic parameters are calibrated against the 3D CFD results on the mock-up geometry. Finally, a first comparison between the results of the 1D model and the

3D models on both full-size and mock-up geometries is performed.

## 2. The HCPB Back Supporting Structure

A view of one HCPB outboard equatorial BM (OB4) is reported in Fig. 2, where the manifolds of the two parallel cooling paths in the BSS are also highlighted [2], see Fig. 2a. The cross section of one of the two sets of coaxial manifolds is shown in Fig. 2b: the inner manifold is called Outlet Manifold because it collects the coolant coming from the BM by means of five circular derivations, whereas the external one is called Inlet Manifold as it delivers the coolant to the BM by means of 58 rectangular derivations (see Fig. 2c).

### 2.1 3D CFD model

A 3D model for each of the two manifolds of the OB4 has been developed using the commercial code STAR-CCM+ v.11.04; the two models are independent as the heat transfer between the Inlet and Outlet Manifolds is neglected; this is consistent with the HCPB design, which assumes a thermal insulation between these two manifolds. The steady state, segregated flow model, with the  $k-\omega$  SST turbulence closure and “all  $y^+$ ” wall treatment is adopted [6]; superficial roughness is neglected. Constant helium properties are used, evaluated at 8 MPa and 300 °C and 500 °C for the Inlet and Outlet Manifolds, respectively; for the purpose of this investigation, the pressure drop in the BM (which is around 1.6 bar [1]) is neglected, and the effect of temperature on the helium properties is considered as dominant (this is also consistent with the CFD analyses performed by the HCPB design team [2]). Fixed mass flow rates are imposed at the main inlet and main outlet (see Table 1 and 2), and fixed uniform pressure of 8 MPa is applied at the derivations (for both manifolds). An example of the flow fields obtained with the 3D models in the two manifolds is reported in Fig. 3, in which also a detail view of the manifolds’ derivations are shown. It is here evident how the derivations in the Outlet Manifold locally cause turbulence in the flow field, whereas the Inlet Manifold derivations, being smaller and more distributed, do not affect the flow field strongly.

### 2.2 1D model

Two separate 1D models for the two manifolds have been developed, neglecting also here the heat transfer between the two. According to the object-oriented philosophy, the model has been developed with a modular structure: the portion of manifold in between two derivations is modelled as a simple pipe, representing the main branch of the manifold, with three connectors representing 1) the main branch inlet, 2) the main branch outlet and 3) the outlet/inlet derivation, located in correspondence to the main branch outlet for Inlet and Outlet Manifolds, respectively (see Fig. 4). Such models are called “Inlet Manifold Derivation” and

“Outlet Manifold Derivation”, respectively. In view of the large number of derivations in the Inlet Manifold, one Inlet Manifold Derivation is intended to actually represent a group of derivations, see below.

Each Inlet and Outlet Manifold module is built linking each main outlet with the main inlet of the following manifold section, as shown in Fig. 5a. The whole segment (see Fig. 5b) is built connecting in series the 7 Inlet and Outlet Manifold modules and finally connecting the whole Inlet and Outlet Manifolds through the BM models, already present in the GETTHEM library [3].

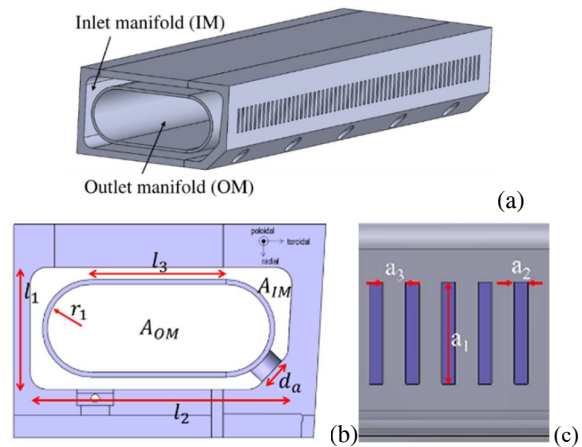

Fig. 2. Isometric view (a) and cross section (b) of the OB4 BSS manifolds; (c) detail of the side view of the Inlet Manifold, showing the derivations delivering the coolant to the FW channels (adapted from [2]).

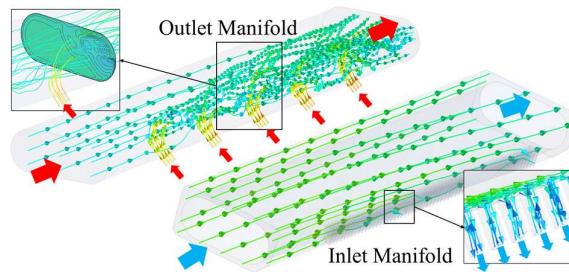

Fig. 3. 3D model of the BBS: computed streamlines in the Outlet (top) and Inlet (bottom) full-size manifolds. Details of the derivations are also shown.

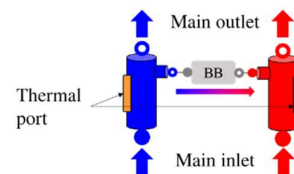

Fig. 4. Sketch of the 1D model used for Inlet Manifold (left) and Outlet Manifold (right) Derivations. The solid circles represent inlet fluid connectors, whereas the open circles represent outlet fluid connectors.

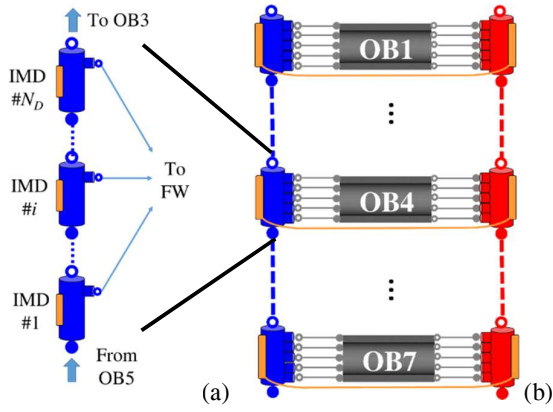

Fig. 5. (a) Sketch of the 1D model of the OB4 Inlet Manifold and (b) sketch of the 1D BB segment model, including thermal coupling and BM models.

Both the derivation models compute the pressure drop along the considered manifold portion, as well as the mass flow rate at the derivation; since the fluid velocity changes considerably between the main branch inlet and the main branch outlet, the pressure drop is computed in terms of total pressure  $p_o = p + \frac{1}{2} \rho v^2$ , where  $p$  is the static pressure,  $\rho$  is the coolant density and  $v$  is the coolant speed (the gravity term can be neglected in view of the small value of the helium density). In particular, the total pressure drop between the inlet and the outlet is computed with the classical definition of major (distributed) pressure losses, equation (1), whereas the minor (localized) pressure drop due to the presence of the derivations is computed according to equation (2). The mass flow rate in the derivations is here computed with equation (3) by means of a mass flow rate distribution coefficient ( $k_{mass}$ ):

$$\Delta p_{o,major} = \frac{1}{2} f \frac{L}{D_h} \rho v_{in}^2 \quad (1)$$

$$\Delta p_{o,minor} = \frac{1}{2} k_{loc} \rho v^2 \quad (2)$$

$$m_{der} = k_{mass} (p_{in/out} - p_{der}) \quad (3)$$

where  $f$  is the Darcy friction factor,  $k_{loc}$  is the localized pressure drop coefficient,  $D_h$  is the hydraulic diameter of the main branch and  $L$  is the distance between two derivations. Finally,  $p_{in/out}$  and  $p_{der}$  are the pressure at main branch inlet/outlet and the pressure at the derivation.

### 3. Dimensioning of the BSS sub-size mock-up

Due to the large value of mass flow rate required, currently no facility could be used to test the full-size BSS; so, a sub-size mock-up is necessary. To dimension such mock-up, the HELOKA facility is considered as reference. A scaling procedure has been identified, to maintain the hydraulic similarity between the full-scale manifold and sub-size mock-up, by keeping constant the dimensionless parameters (i.e. Reynolds number and the

ratios between flow areas and mass flow rates). The constraints coming from the facility are:

- He mass flow rate between 0.2 kg/s and 1.3 kg/s;
- maximum temperature of 500 °C;
- maximum pressure of 9.2 MPa.

The entire scaling down process is performed here on the portion of the BSS related to the OB4.

The independent dimensionless parameters which are relevant for the scaling of the mock-up are the Reynolds number ( $Re$ ) on the main branch and on the derivations, the ratio between the areas of the inlet/outlet derivation and the frontal area of the BSS and the ratio between the mass flow rates on the same sections [7]. The verification of the hydraulic similarity between the full-size and the mock-up has been performed with dedicated CFD simulations [8] on the OB4 BSS portion, and the scaling factor is then applied unmodified to the entire BSS.

### 3.1 Scaling of the Outlet Manifold

Fig. 2b shows the frontal section of the OB4 Outlet Manifold: all the transverse dimensions, as well as the total length, are scaled according to the scaling factor of 15, which is  $\sim$  the ratio between the total segment mass flow rate (17.6 kg/s [2]) and the maximum mass flow rate for HELOKA (1.3 kg/s). The dimensions of the full-size and the mock-up geometries are reported in Table 1. The characteristics of the Outlet Manifold BSS geometry (number and shape of the derivations and shape of the frontal area of the manifold) have been maintained during the scaling process.

Table 1. Parameters of the proposed OB4 Outlet Manifold mock-up, compared to the full-size manifold (see Fig. 2).

Parameter	Full-size	Mock-up
$l_3$ [m]	0.332	0.022
$r_1$ [m]	0.108	0.0072
$d_a$ [m]	0.06	0.004
$A_{OM}$ [m <sup>2</sup> ]	1.08e-1	4.8e-4
$P_{OM}^a$ [m]	1.34	90
$L^b$ [m]	2.88	0.192
$d_{der}^c$ [mm]	450	30
$m_{in}$ [kg/s]	7.2	0.480
$m_{out}$ [kg/s]	10	0.667

<sup>a</sup> Hydraulic perimeter.

<sup>b</sup> Total axial length of the OB4 BSS portion.

<sup>c</sup> Distance between two successive derivations.

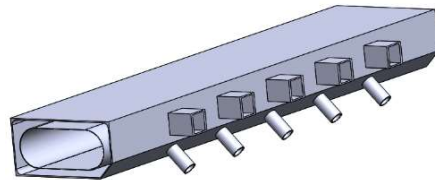

Fig. 6. 3D view of the OB4 BSS sub-size mock-up.

Table 2. Parameters of the proposed OB4 Inlet Manifold mock-up, compared to the full-size manifold (see Fig. 2).

Parameter	Full-size	Mock-up
$l_1$ [m]	0.300	0.020
$l_2$ [m]	0.634	0.042
$l_3$ [m]	0.332	0.022
$a_1$ [mm]	100	6.7
$a_2$ [mm]	13.5	10
$a_3$ [mm]	22.5	30
$A_{IM}$ [m <sup>2</sup> ]	6.53e-2	2.6e-4
$P_{IM}$ [m]	3.21	0.22
$m_{in}$ [kg/s]	10.4	0.693
$m_{out}$ [kg/s]	7.6	0.510

### 3.2 Scaling of the Inlet Manifold

Due to the large number of derivations and their dimensions, consistently with the 1D model as described in Section 2.2, the 58 Inlet Manifold derivations are grouped in five larger derivations (same as the number of the Outlet Manifold derivations, to simplify the coupling between the two), maintaining unchanged the total flow area, see Fig. 5b. A too small derivation, in fact, would be hard to manufacture and could as well be clogged during the experimental campaign. The scaling process is then performed on the grouped geometry (see Table 2). The scaling factor adopted in the Inlet Manifold and the axial length is the same as the Outlet Manifold.

## 4. Mock-up modeling

A 3D (CFD) model of the OB4 region of sub-size mock-up, as well as a 1D model, have been developed, similarly to what has been done for the full-size BSS, see above. The calibration of the 1D model is performed extracting the needed parameters (friction factors and mass flow rate factors) from the CFD simulations run on the mock-up geometries of both manifolds using the same boundary conditions (fixed mass flow rate at the main branch inlet/outlet and pressure at the derivations) as in the 1D model.

The 1D model is then benchmarked (keeping unmodified the parameters) against CFD simulations on the full-size OB4 geometries, to check the representativeness with respect to the actual object. The rationale behind this strategy is that the model may be eventually calibrated against the experimental results on the mock-up, still allowing to describe the behavior of the full-size BSS.

The results of the 1D model benchmark against the CFD results are presented in Fig. 7. The total pressure drop along the main branch axis is computed for both the 3D and the 1D simulations, and reported in the form of a “pseudo-dimensionless” pressure drop defined as  $\Delta p_o D_h^2$  (where  $D_h$  is the hydraulic diameter) as a function of the axial position normalized with respect to  $D_h$ . For the Outlet Manifold, in view of the large oscillation of the pressure along the main branch axis (Fig. 7a), an average friction factor, considering both localized and distributed pressure drop, is evaluated from the mock-up CFD; this

implies that such friction factor cannot be compared with any known correlation. Hence, to derive an ad-hoc correlation for the friction factor, the mock-up CFD simulations are also performed modifying the mass flow rates to cover the hydraulic conditions of the whole segment, leading to the correlation

$$f_{OM} = 5667 \text{ Re}^{-0.8329} \quad (4)$$

which is then used to determine the friction factor in the 1D model.

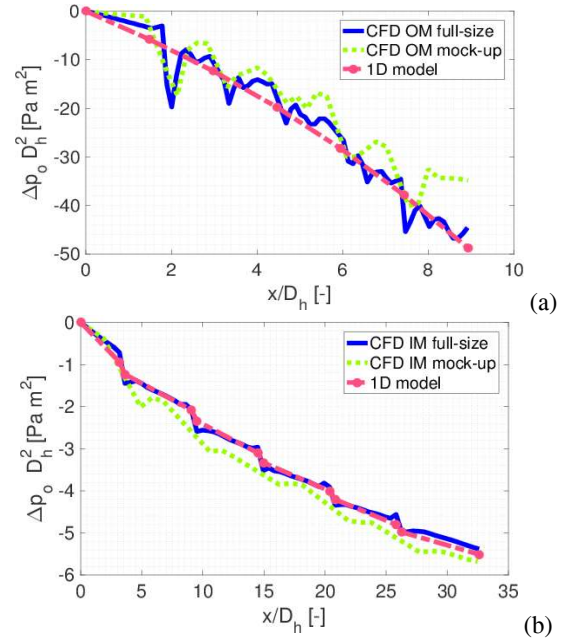

Fig. 7. Pseudo-dimensionless pressure drop distributions computed with the 1D and the 3D models in the Outlet (a) and Inlet (b) Manifold, for the mock-up (dashed, 1D and dotted, 3D) and full-size (solid, 3D) BSS, respectively.

The same rationale has been used for the Inlet Manifold; however, in this case, thanks to the very smooth pressure drop behavior between two “grouped” derivations (see Fig. 7b), it has been possible to evaluate different friction factors for the different portions of the manifold from the mock-up CFD, excluding the localized pressure drops due to the presence of the derivations. Such friction factors are in agreement with those given by the Petukhov correlation [9] (maximum relative error < 30 %), thus allowing to use such correlation inside the 1D model. For the Inlet Manifold, consequently, also an average value of the localized pressure drop coefficient was needed, due to the presence of the derivations, and has been determined from the mock-up CFD.

From Fig. 7a it is clear that the 1D Outlet Manifold model cannot correctly reproduce the fluctuations in the pressure along the axis, but the average pressure distribution results very accurate when compared against

the full-size BSS; this is anyway consistent with the level of detail of the 1D model. For the Inlet Manifold, instead, thanks to the opportunity to evaluate separately the localized and distributed pressure drops, the pressure distribution shows an excellent agreement among the models, see Fig. 7b.

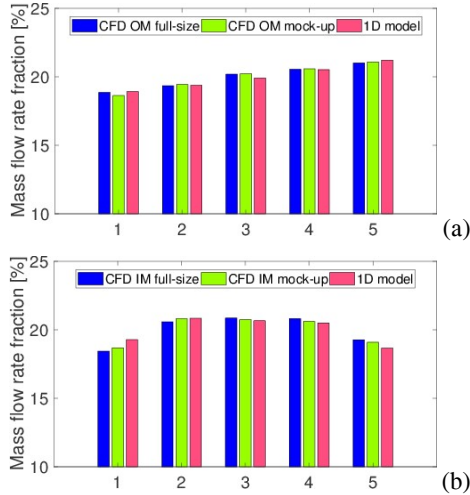

Fig. 8. Mass flow rate distributions computed with the 1D and the 3D models in the Outlet (a) and Inlet (b) Manifold of the mock-up (pink, 1D and green, 3D) and full-size (blue, 3D) BSS, respectively.

The comparison between the 1D and the 3D models is also performed in Fig. 8 monitoring the computed fraction of the mass flow rate delivered to each derivation. The mass flow rate distribution coefficients are evaluated separately for all derivations from the mock-up CFD results, according to equation (3), for both manifolds; then, the average values of  $k_{mass}$  are used in the 1D models. The mass flow rate distribution among the derivations reproduces very well the behavior of CFD simulations, as shown in Fig. 8, in both manifolds, with deviations from the CFD of the full-size manifold below 5%. In the Inlet Manifold Fig. 8b) the mass flow rates computed in the 58 derivations of the CFD full-size model are lumped according to the grouping rationale adopted in the definition of the mock-up, in order to consistently compare the results obtained with the two geometries.

## 5. Conclusions and perspective

A simplified 1D model of the HCPB BSS manifolds (limited to the OB4 BM) have been developed, for the purpose of integrating a robust 1D description of these manifolds into the system-level GETTHEM code.

A sub-size mock-up of the BSS has been dimensioned, which will be tested in an experimental campaign at KIT, whose results will also allow validating the 1D model. Starting from the OB4 BSS full-size geometry, a scaling

rationale has been identified, with the aim of maintaining constant the dimensionless groups relevant to the 1D computation of pressure distributions and mass flow rates. The scaling factor identified here will then be applied to the entire BSS, to obtain the full mock-up geometry.

The 1D model, developed also for the BSS mock-up, has been calibrated exploiting the results of the 3D CFD simulations on the mock-up geometry. After the calibration, the 1D model has been benchmarked against the CFD simulations of the full-size geometry, showing a very good capability to reproduce the 3D results both in terms of pressure distribution along the main branch of the manifolds and of mass flow rate through the derivations.

In the next step, the 1D model will be extended to the entire segment, thus allowing the connection of the 1D manifold model with the BM models already developed in GETTHEM.

## Acknowledgements

This work has been carried out within the framework of the EUROfusion Consortium and has received funding from the Euratom research and training programme 2014-2018 under grant agreement No. 633053. The views and opinions expressed herein do not necessarily reflect those of the European Commission.

## References

- [1] F. A. Hernández González, et al., A new HCPB breeding blanket for the EU DEMO: Evolution, rationale and preliminary performances, *Fusion Engineering and Design* (2017), <http://dx.doi.org/10.1016/j.fusengdes.2017.02.008>.
- [2] F. A. Hernández González, et al., “DDD 2015 for HCPB,” EFDA\_D\_2MRQ4E, 2016.
- [3] A. Froio, et al., Dynamic thermal-hydraulic modelling of the EU DEMO HCPB breeding blanket cooling loops, *Progress in Nuclear Energy* 93 (2016) 116-132.
- [4] A. Froio, et al., Dynamic thermal-hydraulic modelling of the EU DEMO WCLL breeding blanket cooling loops, *Fusion Engineering and Design* (2017), <http://dx.doi.org/10.1016/j.fusengdes.2017.01.062>.
- [5] B.-E. Ghidersa, et al., Helium Loop Karlsruhe (HELOKA): A valuable tool for testing and qualifying ITER components and their He cooling circuits, *Fusion Engineering and Design* 81 (2006) 1471-1476.
- [6] Star-CCM+ User's Manual 11.04.
- [7] D. S. Miller, Internal Flow Systems, Cranfield, Bedford, UK: BHRA Fluid Engineering Series, Vol. 5, British Hydromechanics Research Association, 1978.
- [8] A. Bertinetti, et al., Dimensioning and modelling of a scaled-down mock-up of a back supporting structure (BSS) segment, EFDA\_D\_2LWV4A v1.0 (2017).
- [9] B. S. Petukhov, Heat transfer and friction in turbulent pipe flow with variable physical properties, *Advances in Heat Transfer* Vol. 6, 503-564 New York, Academic Press, 1970.